

Product datasheet

Eccentric Roll Crusher – ERC[®] 25-25

The smartest tool for crushing hard rock

Our Eccentric Roll Crusher (ERC[®]) is a game-changer for primary crushing of hard rock and ore in underground and surface operations. Compact and robust, our ERC[®] features an integrated screen, which provides significantly higher efficiency and greater capacity than conventional primary crushers.

Benefits

- CAPEX reduction of up to 10% for the overall plant
- High efficiency with up to 40% energy cost savings
- Up to 10% higher throughput compared to industrial benchmarks
- High reduction ratios of up to 1:10 will often eliminate a secondary stage
- Low maintenance, greater reliability

Eccentric Roll Crusher

– ERC[®] 25-25

Increase productivity with a revolutionary roll crusher

The ERC 25-25 is a revolution in primary crushing that delivers increased capacity, reduced energy consumption and lower operating costs. With the two-machines-in-one concept, combining a crusher and a screen, the ERC 25-25 has a compact design that simplifies transportation, installation and maintenance.

Flexible machine setting

The crushing jaw of the ERC 25-25 features a patented fully hydraulic gap setting/retraction system with a wide gap setting range. This allows safe and simple adjustment of product size, compensation of liner wear and release of uncrushable material like tramp metal, resulting in lower maintenance costs and increased reliability.

Highly energy efficient crushing

The ERC 25-25 is designed for outstanding comminution intensity, high throughput and the most efficient use of crushing energy, thanks to the particularly effective kinematic of the oscillating roll, with constant stroke across the entire crusher cavity.

The high moments of inertia of the roll and flywheels contribute to accumulated crushing energy and effectively compensate for the load peaks that occur during comminution. The integrated screen increases the efficiency of the machine, as fine material is bypassed directly and not passed through the crushing chamber. This reduces energy consumption and the risk of material compacting and overloading the crushing chamber.

Suitable for mobile and semi-mobile crushing systems

The symmetrical arrangement of the roll allows the crusher to be balanced with great precision. This significantly reduces machine vibrations and loads on surrounding structures, and makes the crusher ideal for use in both mobile and semi-mobile crushing systems.

Technical specification

Application data	
Application	Primary crushing
Feed material	Hard rock and ore
Capacity ¹	1,450 – 4,900 metric t/h

Technical data	
Configuration	Single roll with integrated static grizzly
Feed opening ²	2,500 mm x 1,300 mm
Roll diameter	2,500 mm
Roll width	2,500 mm
Grizzly length ³	Standard length approx. 2,500 mm
Gap setting method / adjustment range CSS ⁴	Hydraulic / 100 – 260 mm (adjustment path 200 mm)
Tramp metal release method	Hydraulic – overload system
Drive concept	V-belt
Installed drive motor power ⁵	450 to 600 kW

Weight and dimensions	
Total weight ⁶	Approx. 185,000 kg
Heaviest piece for transportation ⁷	Approx. 80,000 kg
Heaviest piece for usual maintenance ⁸	Approx. 15,700 kg
Main dimensions (l x w x h)	Approx. 7,100 mm x 4,700 mm x 4,300 mm

1. The actual throughput depends on the feed material characteristics (e.g. bulk density, hardness UCS, feed particle size distribution, moisture content), the desired product size and the selected machine settings (e.g. gap setting CSS).
2. Height h = maximum dimension between jaw liners and roll liners.
3. Standard length. Screen length may vary depending on actual machine configuration.
4. CSS = Closed side setting.
5. Motor rating range applicable, actual motor rating depending on the feed material characteristics, desired product size, actual machine configuration and altitude.
6. Crusher weight indicated does not include base frame, drive motor and tools. Weight may vary depending on actual machine configuration.
7. Roll with bearings and liner.
8. Hood with liner.

Main components

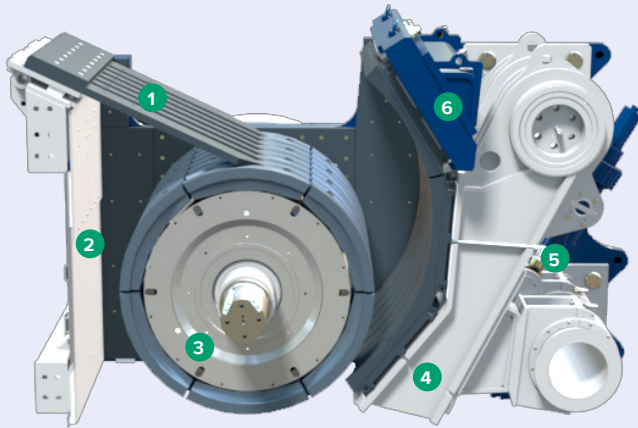

1. Integrated static grizzly
2. Housing
3. Roll
4. Jaw
5. Hydraulic gap setting system
6. Hood

Operation principle

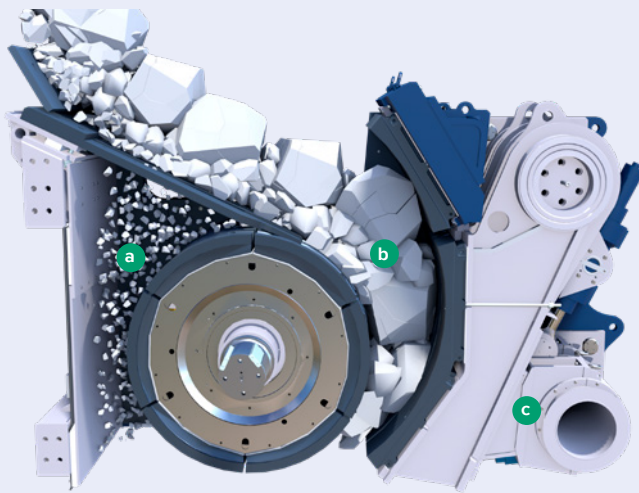

Fine particles fed into the crusher are screened by the integrated static grizzly and bypassed through the crusher housing (a). The coarse feed material fraction is continuously crushed between the oscillating roll and the jaw until the product exits the crushing chamber at the bottom (b). The integrated hydraulic gap setting system allows for wear liner compensation, release of uncrushable material like tramp metal and gap adjustment (c).

FLSmidth A/S
2500 Valby
Denmark
Tel. +45 3618 1000
info@flsmidth.com

www.flsmidth.com

FLSmidth Inc.
Salt Lake City Operations
Midvale, UT 84047-5559
USA
Tel. +1 801 871 7000
info.sl.c@flsmidth.com

**FLSmidth Mining
Technologies GmbH**
Ennigerloh Operations
59320 Ennigerloh
Germany
Tel. +49 201 828 3000
mining-technologies@flsmidth.com

Copyright © 2023 FLSmidth A/S.
All Rights Reserved. FLSmidth and
FLS are (registered) trademarks of
FLSmidth A/S. This brochure makes
no offers, representations or
warranties (express or implied), and
information and data contained in this
brochure are for general reference
only and may change at any time.
All illustrations are examples.